

apuro

**25L 1000W
Commercial
Programmable
Microwave**
Instruction manual



**Model:
FB862-A**

Safety Instructions

To reduce the risk of fire, electric shock, injury to persons or exposure to excessive microwave oven energy when using your appliance, follow basic precautions, including the following:



PRECAUTIONS TO AVOID POSSIBLE EXPOSURE TO MICROWAVE ENERGY

Do not attempt to operate this oven with the door open, since this can result in harmful exposure to microwave energy. It is important not to break or tamper with the safety interlocks.

Do not place any object between the oven front face and the door or allow soil or cleaner residue to accumulate on sealing surfaces.

Warning: If the door or door seals area damaged, the oven must not be operated until it has been repaired by a competent person.

- Position on a flat, stable surface.
- A service agent/qualified technician should carry out installation and any repairs if required. Do not remove any components on this product.
- Consult Local and National Standards to comply with the following:
 - Health and Safety at Work Legislation
 - Fire Precautions
 - Wiring Regulations
 - Building Regulations
- **Warning:** Liquids and other foods must not be heated in sealed containers since they are liable to explode.

- **Warning:** It is hazardous for anyone other than a competent person to carry out any service or repair operation that involves the removal of a cover which gives protection against exposure to microwave energy.
- Only use utensils suitable for use in microwave ovens.
- The oven should be cleaned regularly and any food deposits should be removed.
- When heating food in plastic or paper containers, keep an eye on the oven due to the possibility of ignition.
- If smoke is observed, switch off or unplug the appliance and keep the door closed in order to stifle any flames.
- Do not overcook food.
- Do not use the oven cavity for storage purposes. Do not store items, such as bread, cookies, etc. inside the oven.
- Remove wire twist-ties and metal handles from paper or plastic containers/bags before placing them in the oven.
- Install or locate this oven only in accordance with the installation instructions provided.
- Eggs in the shell and whole hard-boiled eggs should not be heated in microwave ovens since they may explode, even after microwave heating has ended.
- Use this appliance only for its intended uses as described in manual. Do not use corrosive chemicals or vapours in this appliance. This oven is especially designed to heat. It is not designed for industrial or laboratory use.
- Do not store or use this appliance outdoors.
- Do not use this oven near water, in a wet basement or near a swimming pool.
- The temperature of accessible surfaces may be high when the appliance is operating. The surfaces are liable to get hot during use. Keep cord away from heated surface, and do not cover any vents on the oven.

- Do not let cord hang over edge of table or counter.
- Failure to maintain the oven in a clean condition could lead to deterioration of the surface that could adversely affect the life of the appliance and possibly result in a hazardous situation.
- **Warning:** The contents of feeding bottles baby food jars shall be stirred or shaken and the temperature checked before consumption, in order to avoid burns.
- **Warning:** Microwave heating of beverages result in delayed eruptive boiling, therefore care must be taken when handling the container.
- Liquids such as water, coffee and tea can overheat beyond boiling point without appearing to be boiling.
- Always switch off and disconnect the power supply to the unit before cleaning or carrying out maintenance.
- Keep all packaging away from children. Dispose of the packaging in accordance to the regulations of local authorities.
- If the power cord is damaged, it must be replaced by an Apuro agent or a recommended qualified technician in order to avoid a hazard.
- This appliance is not intended for use by persons (including children) with reduced physical, sensory or mental capabilities, or lack of experience or knowledge, unless they have been given supervision or instruction concerning the use of the appliance by a person responsible for their safety.
- Children should be supervised to ensure that they do not play with the appliance.
- Do not operate the oven when empty.
- The microwave oven shall not be placed in a cabinet unless it has been tested in a cabinet.
- The appliance is not intended to be operated by means of an external timer or separate remote-control system.

- Do not use jet/pressure washers to clean the appliance.
- Apuro recommend that this appliance should be periodically tested (at least annually) by a Competent Person. Testing should include, but not be limited to: Visual Inspection, Polarity Test, Earth Continuity, Insulation Continuity and Functional Testing.

Introduction

Please take a few moments to carefully read through this manual. Correct maintenance and operation of this machine will provide the best possible performance from your Apuro product.

Pack Contents

The following is included:

- Microwave Oven
- Instruction manual

Apuro prides itself on quality and service, ensuring that at the time of packaging the contents are supplied fully functional and free of damage.

Should you find any damage as a result of transit, please contact your Apuro dealer immediately.

Installation

1. Remove all packaging materials. Make sure that all protective plastic film and coatings are thoroughly removed from all surfaces.



Warning: Check for any of the following damage that may have occurred:

- **Misaligned or bent door, damaged door seals/sealing surface, broken/loose door hinges, dents in the oven interior.**
- **DO NOT operate the oven if any damage is found. Call a Apuro agent or qualified Technician.**

2. Position the oven on a flat, stable and heat-resistant surface. For sufficient ventilation, allow a minimum of 30cm of space above the oven, 10cm at the back and sides. The left side must be open.



Note: Do not cover or block any openings on the appliance, or remove the feet.

3. Place the oven as far away from radios and TV as possible as operation of the appliance may cause interference to your radio or TV reception.

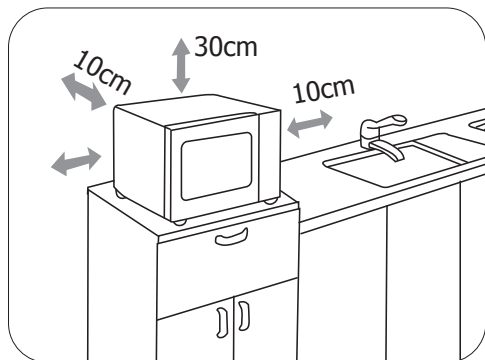

Utensils

See the instructions in this chapter for utensils to use/avoid with microwaving. If in doubt, please check the manufacturer's instructions if your utensil is microwave safe or not.

Materials you can use in microwave oven

Utensils (Not included)	Remarks
Browning dish	Follow manufacturer's instructions. The bottom of browning dish must be placed smoothly on the ceramic board. Incorrect usage may the ceramic board to break.
Dinnerware	Microwave-safe only. Follow manufacturer's instructions. Do not use cracked or chipped dishes.
Glass jars	Always remove lid. Use only to heat food until just warm. Most glass jars are not heat resistant and may break.
Glassware	Heat-resistant oven glassware only. Make sure there is no metallic trim. Do not use cracked or chipped dishes.
Oven cooking bags	Follow manufacturer's instructions. Do not close with metal tie. Make slits to allow steam to escape.
Paper plates and cups	Use for short-term cooking/warming only. Do not leave oven unattended while cooking.
Paper towels	Use to cover food for reheating and absorbing fat. Use with supervision for a short-term cooking only.
Parchment paper	Use as a cover to prevent splattering or a wrap for steaming.
Plastic	Microwave-safe only. Follow the manufacturer's instructions. Should be labelled "Microwave Safe". Some plastic containers soften, as the food inside gets hot. "Boiling bags" and tightly closed plastic bags should be slit, pierced or vented as directed by package.
Plastic wrap	Microwave-safe only. Use to cover food during cooking to retain moisture. Do not allow plastic wrap to touch food.
Thermometers	Microwave-safe only (meat and candy thermometers)
Wax Paper	Use a cover to prevent splattering and to help retain moisture

Materials to be avoided in microwave oven

Utensils (Not included)	Remarks
Aluminium tray	May cause arcing. Transfer food into microwave-safe dish
Food carton with metal handle	May cause arcing. Transfer food into microwave-safe dish
Metal or metal-trimmed utensils	Metal shields the food from microwave energy. Metal trim may cause arcing
Metal twist ties	May cause arcing and could cause a fire in the oven
Paper bags	May cause a fire in the oven
Plastic foam	Plastic foam may melt or contaminate the liquid inside when exposed to high temperature
Wood	Wood will dry out when used in the microwave oven and may split or crack

Knowing your appliance

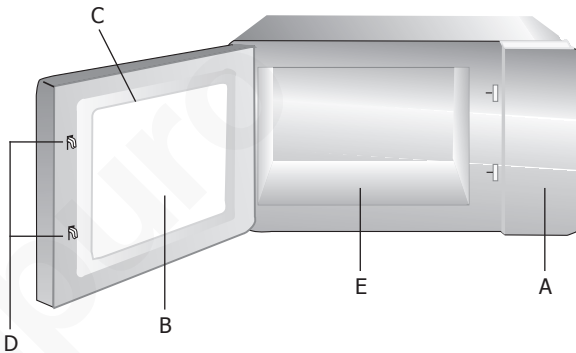

- A) Control panel
- B) Observation window
- C) Door assembly
- D) Safety interlock system
- E) Ceramic board

Note:

1. DO NOT press the ceramic board forcibly.
2. Take and put utensils gently to avoid damage to the ceramic board.
3. After use, DO NOT touch the ceramic board with hand to avoid high temperature scalding.

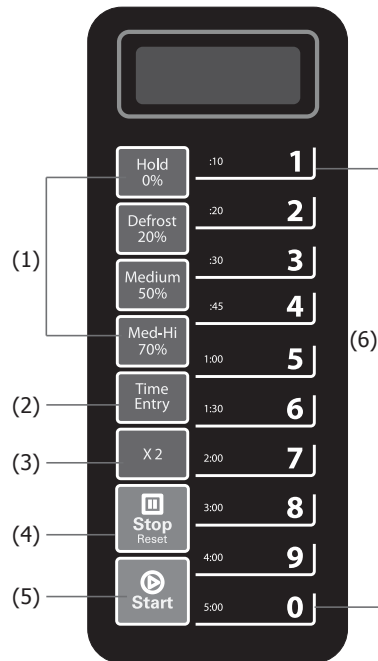

- (1) Power level buttons
- (2) Time Entry Button
- (3) X2 Button
- (4) Stop/Reset Button
- (5) Start Button
- (6) Number Buttons

Power levels

There are five power levels available.

Level	High	Med High	Medium	Defrost	Hold
Power	100%	70%	50%	20%	0%
Display	PL10	PL7	PL5	PL2	PL0

Appendix A: User Options

Values bold in the table below are the default settings.

Option	Setting	Description
1 EOC Tone	OP:10	3 seconds beep
	OP:11	Continuous beep
	OP:12	5 quick beeps, repeating
2 Beeper Volume	OP:20	Beeper Off
	OP:21	Low
	OP:22	Medium
	OP:23	High
3 Beeper On/Off	OP:30	Key beep Off
	OP:31	Key beep On
4 Keyboard Window	OP:40	15 seconds
	OP:41	30 seconds
	OP:42	60 seconds
	OP:43	120 seconds
5 On the Fly	OP:50	On-the-Fly Disable
	OP:51	On-the-Fly Enable
6 Door Reset	OP:60	Door reset Disable
	OP:61	Door reset Enable
7 Max time	OP:70	60 Minute Maximum cook time
	OP:71	10 Minute Maximum cook time
8 Manual Programming	OP:80	Manual Programming Disable
	OP:81	Manual Programming Enable
9 Double digit	OP:90	Single Digit Mode-10 programs
	OP:91	Double Digit Mode-100 programs

Appendix B: Default Cook Time

The oven will be shipped with the following Preset Cook Time unless otherwise noted in the product Specification.

Number Button	Display (Time in Minute)	Power
1	0:10	100%
2	0:20	100%
3	0:30	100%
4	0:45	100%
5	1:00	100%
6	1:30	100%
7	2:00	100%
8	3:00	100%
9	4:00	100%
0	5:00	100%

Operation

1. Power up

When the oven is electrified for the first time, "-- --" is shown. If  button pressed, the oven will change to idle mode.

Note: Under idle mode, no button can be pressed.

2. Idle Mode

- Entry:** The oven will enter idle mode after a set of seconds have expired in Ready Mode without a keyboard pressed or door opened and closed. The number of seconds is determined by the keyboard Timeout Window, set by User Option 4.
- During idle mode, the display is blank. And there will be no oven activity.

3. Ready Mode

In this mode, the oven is ready to begin either a manual or preset cooking cycle.



- Opening and closing the door while in Idle Mode will put the oven into Ready Mode.
- During Ready Mode, "0:00" is shown.
- From the Ready Mode, the oven can go to almost all of the other modes.

4. Door Open Mode

1. When the door is open, the oven will enter Door Open Mode. This allows for entry into Programming Mode.
 2. During this mode, the display is blank. The fan and oven lamp will work.
 3. When the door is closed, if User Option OP:60 is selected and the oven was running a manual or preset cook cycle, the oven will enter Pause Mode. In all other cases, the oven will return to Ready Mode with User Option OP:61 selected.
- **Note:** Opening and closing the door will clear out any information about a Manual or Preset Program which was running.







5. Pause Mode

This mode enables the user to temporarily stop the cooking cycle so as to inspect or stir food.

1. While in Manual Cook Mode or Preset Program Cook Mode, if the door is open and then closed, or if  is pressed, the oven will enter Pause Mode.
2. While paused, the display will show the remaining cooking time.
3. Pause Mode will return to Idle Mode in the exact fashion as Ready Mode, depending on User Option 4 setting. Additionally, if  button is pressed, the oven will immediately enter Ready Mode. Or if  pressed, the oven will continue to run the cooking cycle.

6. Manual Cook Mode

The user can manually set cooking time and power level while in this mode.

1. While in Ready Mode, press  button to enter Manual Cook Mode. The display will show "00:00".
2. Press the number buttons to input the cooking time as needed.
3. Press , ,  or  button to select power level. The display will show the related power. If the same button pressed twice, the power level will change to full power.
4. Press  to start manual cooking.
5. Remaining cooking time is displayed. The fan and oven lamp will work.
6. When cooking program finishes, the oven will enter End of Cook Cycle Mode.

7. End of Cook Cycle Mode

1. After a Manual Cook Mode or a Preset Program Cook Mode expires , the oven will enter End of Cook Cycle Mode.
2. During this mode, "End" is shown.
3. If User Option OP:11 or OP:12 is selected, the oven will continue to sound until the user acknowledges this by either opening and closing the door or pressing  **Stop** Reset. If User Option OP:10 is selected, after 3 seconds beeping, the oven will enter Ready Mode.

8. Preset Program Cook Mode



1. This mode allows cooking through a one-button-touch operation. While in Ready Mode, press one of the number buttons to run a Preset Program for relative cooking time.
2. The remaining cooking time is shown. If it is multi-stage cooking, the total remaining cooking time is displayed.
 - **Note:** If the chosen program exceeds the maximum time allowed by User Option 7, the oven will beep 3 times rapidly and display "00:00" to indicate the program is unacceptable.
3. When cooking program finishes, the oven will enter End of Cook Cycle Mode.

9. On the Fly Cooking

1. While the oven is cooking, if User Option OP:51 is selected, pressing a number button will enable a preset cooking program to start automatically.
2. The display shows the remaining cooking time.
3. When cooking program finishes, the oven will enter End of Cook Cycle Mode.

10. Programming Mode

This mode allows the user to set cooking time and power level to the preset programs of the number buttons.

1. Open the door. Then press the number button "1" for 5 seconds, the buzzer will sound once and enter Programming Mode.
2. "ProG" is shown.
3. Press the number button, e.g. "3", the program will be saved into "3". The default cooking time "0:30" is shown. Now you can press the number buttons to set the desired cooking time.
4. Press $\frac{\text{Hold Defrost Medium}}{0\% \text{ ' } 20\% \text{ ' } 50\%}$ or $\frac{\text{Med-Hi}}{70\%}$ to set the power level. The display will show the related power. If the same button pressed twice, the power will change to full power.
5. After setting cooking time and power, press  to save. When saved, "ProG" is shown.
 - **Note:** If all the cooking time exceeds the maximum time allowed by User Option 7, when pressing  to save the program, the buzzer will sound 3 times briefly and display will show "00:00" to indicate the time is not valid. Then the display will turn back to show "ProG". The time set before will have no change.
6. Close the door, the oven will turn back to Ready Mode.
 - **Note:** If pressing  during setting, the oven will turn to Door Open Mode. The program that is not saved will be lost. If there is program saved as memory procedure, press the related number button, the saved program will start. If no program saved, the buzzer will alarm when pressing number buttons and thus it will not work.

For example, if desired to set a program as memory program, with power level PL7 and cooking time of 1 minute and 25 seconds, please follow below operations:

Step1:	Open the door. Then press number button "1" for 5 seconds, "ProG" is shown.
Step2:	Press the number button, e.g. "3", the program will be saved into "3". The default cooking time "0:30" is shown.
Step3:	Press number buttons "1", "2" and "5" to set the cooking time. "1:25" is shown.
Step4:	Press $\frac{\text{Med-Hi}}{70\%}$. "PL7" is shown. Setting is now finished.
Step5:	Press  to save. "ProG" is shown again. When to use the program next time, just press number button "3", the related program will start automatically.

Note:

- If the power supply is cut off, the saved program will not be lost.
- If the program needs to reset, just repeat the above steps.
- If pressing  at the last step, it will return to Ready Mode. All settings will not be saved.

11. Double cooking time

By using "X2" button, the user can easily set the doubled cooking time for a particular food item.

- In Ready state, press "X2" button first, then within 5 seconds press a number button (0-9). The oven will start cooking with the doubled cooking time. Or, press the number button (0-9) to start cooking first, then within 5 seconds press "X2" button to start cooking with the doubled cooking time.
- When pressing "X2", the display will show "doub". When pressing number buttons, the doubled cooking time will be shown.
 - For example, press the number button "5" (whose preset time is 1 minute) first. Then press "X2", the total cooking time will change to $1:00 \times (1+0.8) = 1:48$ (1 minute and 48 seconds). **Please note "0.8" here means the default proportion setting for double cooking time.**
- When cooking program finishes, the oven will enter End of Cook Cycle Mode.
 - Note: This function cannot be used under memory mode.**

12. Stage Cooking Program

This function allows the user to cook food items at combination of various Power Levels. Three stages can be set at most.

- After setting cooking time and power for the first stage, press "Time Entry" to set the second stage. Then the same step to set the third stage.
- Press "Start" to save.

Example: If desired to set a 3-stage cooking cycle as a memory program (The first stage is with cook time of 1 minute and 25 seconds and power level PL7; the second stage with cook time of 5 minutes and 40 seconds and power level PL5; the third stage with cook time of 1 minute and 30 seconds and power level PL2), please follow below operations:



Step1:	Open the door. Then press number button "1" for 5 seconds, "ProG" is shown.
Step2:	Press the number button, e.g. "3", the program will be saved into "3". The default cooking time "00:30" is shown.
Step3:	Press number buttons "1", "2", "5" to set the cooking time. "1:25" is shown.
Step4:	Press $\begin{matrix} \text{Med-Hi} \\ 70\% \end{matrix}$. "PL7" is shown. Now the first stage is finished.
Step5:	Press $\begin{matrix} \text{Time} \\ \text{Entry} \end{matrix}$. "S-2" is shown.
Step6:	Press number buttons "5", "4", "0" to set the cooking time. "5:40" is shown.
Step7:	Press $\begin{matrix} \text{Medium} \\ 50\% \end{matrix}$. "PL5" is shown. Now the second stage is finished.
Step8:	Press $\begin{matrix} \text{Time} \\ \text{Entry} \end{matrix}$. "S-3" is shown.
Step9:	Press number buttons "1", "3", "0" to set the cooking time. "1:30" is shown.
Step10:	Press $\begin{matrix} \text{Defrost} \\ 20\% \end{matrix}$. "PL2" is shown. Now the third stage is finished.
Step11:	Press $\begin{matrix} \text{Start} \end{matrix}$ to save. "ProG" is shown again. When to use the program next time, just press number button "3", the related program will start automatically.

13. User Option Mode



This allows the user to choose between various ways for the oven to operate.

1. Open the oven door and press "2" for 5 seconds to enter User Option mode.
2. The display shows "OP: - -".
3. Press any number button to enter related mode setting.
 - For example: Setting the voice of the buzzer to medium. Press "2", "OP:22" is displayed. If you want to change, keep pressing "2", the display will show "OP:20", "OP:21", "OP:22", "OP:23", "OP:20".....in cycle.
4. Press  to save the current setting. After saved, "OP: - -" is displayed again.

Notes:

- During setting, press  to enter Door Open Mode. Close the door to enter Ready Mode.
- If  button not pressed at the last step, the program cannot be saved but returns to previous state.

14. Service Mode

1. Open the door and press "3" for 5 seconds to enter service mode.
2. The display shows "SERU".
3. To check the times of closing or opening the door, just press number button "3", the display will show the times.
4. Press  then press number button "4" in 4 seconds, the message will be cancelled. "4-CL" is displayed.
5. Press  to enter Door Open Mode. Close the door to enter Ready Mode.

15. Inquiry Function

- During microwave cooking, press  to check the power level.
- The display shows the power for 3 seconds then turns back to previous state.
- This function is available for multi-stage cooking.

16. Factory-default setting

In power up and ready mode, press  and "0" to check the factory-default setting.

- If it is in the factory default setting, the display will show "11".
- If NOT in the factory default setting, the display will show "00".
- If desired to restore the default setting, press  again. The display will show "11". Now the factory-default settings are restored.
- **Note: Be careful of the operations as it will restore all the factory-default settings.**

Cleaning, Care & Maintenance



- **Switch off and disconnect from the power supply before cleaning and maintenance.**
- **Always keep the oven clean!**
- **Clean the door frame, seal and neighbouring parts carefully with a damp cloth when dirty.**

Cleaning the door and oven front face

- For best performance and to maintain the high degree of safety, the inner door panel and oven front face should be free of food or grease build-up.
- Wipe these parts with a mild detergent, rinse and wipe dry. Never use abrasive powders or pads.

Cleaning the control panel and plastic parts

- Do not apply a detergent or an alkaline liquid spray to the control panel and plastic parts, as this may cause damage to these parts.
- Use a dry cloth (not a soaked cloth) to clean these parts.
- Do not allow the control panel to become wet.

Cleaning the oven interior

- After use be sure to remove spilled liquids, spattered oil and food debris as quickly as possible.
- If the oven is used when dirty, efficiency drops and the dirt gets stuck on the oven surface. This may cause bad odours.
- Clean the interior with a cloth soaked in luke-warm water with a mild detergent dissolved in it, then rinse the soap off with a damp cloth.



Remove any odours in the oven interior by microwaving a cup of water with the juice of 1 lemon for 5 minutes. Wipe the oven clean with a soft dry cloth.



Caution: Personal Injury Hazard!
It is hazardous for anyone other than a competent person to carry out any service or repair operation that involves the removal of a cover which gives protection against exposure to microwave energy.



Caution: Do Not wipe plastic and painted sections of the oven with bleach, thinners or other cleaning agents, as this may cause these parts to dissolve or distort.

Troubleshooting

A qualified technician should carry out repairs if required.

Fault	Probable Cause	Solution
The unit is not working	The unit is not switched on	Check the unit is plugged in correctly and switched on
	Plug or lead is damaged	Replace plug or lead
	Mains power supply fault	Check mains power supply
	Door is not closed properly	Close door securely
Arcing/Sparking	Metallic or other inappropriate materials are being used in food preparation	Remove metal objects. Use microwave-safe utensils only
	Spilled food remains inside the oven	Clean the interior of the oven
	The oven is operated when empty	Do not operate the oven when empty. It is very dangerous
Microwave oven interfering with TV reception	Radio and TV reception is interfered when then appliance is operating	It is normal
Steam accumulating on door and hot air out of vents	In cooking, steam may come out of food. Most will get out of vents but some may accumulate on cool places like the oven door	It is normal
Dim oven light	In low power microwave cooking, oven light may become dim	It is normal

Technical Specifications

Note: Due to our continuous improvement process, the product specifications are subject to change without notice.

Model	Voltage	Power	Microwave Output	Oven Capacity	Operation Frequency	Dimensions h x w x d (mm)	Weight (kg)
FB862-A	230-240V~ 50Hz	1550W	1000W	25L	2450MHz	311 x 511 x 432	14.7

Electrical Wiring

The plug is to be connected to a suitable mains socket.

This appliance is wired as follows:

- Live wire (coloured brown) to terminal marked L
- Neutral wire (coloured blue) to terminal marked N
- Earth wire (coloured green/yellow) to terminal marked E

This appliance must be earthed.



If in doubt consult a qualified electrician.

Electrical isolation points must be kept clear of any obstructions. In the event of any emergency disconnection being required they must be readily accessible.

Compliance

The product must not be disposed of as household waste. To help prevent possible harm to human health and/or the environment, the product must be disposed of in an approved and environmentally safe recycling process. For further information on how to dispose of this product correctly, contact the product supplier, or the local authority responsible for waste disposal in your area.

Apuro parts have undergone strict product testing in order to comply with regulatory standards and specifications set by international, independent, and federal authorities.

Apuro products have been approved to carry the following symbol:



All rights reserved. No part of these instructions may be produced or transmitted in any form or by any means, electronic, mechanical, photocopying, recording or otherwise, without the prior written permission of Apuro. Every effort is made to ensure all details are correct at the time of going to press, however, Apuro reserves the right to change specifications without notice.

DECLARATION OF CONFORMITY

- Conformiteitsverklaring • Déclaration de conformité • Konformitätserklärung • Dichiarazione di conformità •
• Declaración de conformidad • Declaração de conformidade

Equipment Type • Uitrustingstype • Type d'équipement • Gerätetyp • Tipo di apparecchiatura • Tipo de equipo		Model • Modèle • Modell • Modello • Modelo			
25L 1000w Manual Commercial Microwave Oven		FB861-A			
25L 1000w Programmable Commercial Microwave Oven		FB862-A			
34L 1800w Programmable Commercial Microwave Oven		FB864-A			
17ltr 1800w Programmable Commercial Microwave Oven		FB865-A			
Application of Territory Legislation & Council Directives(s) Toepassing van Europese Richtlijn(en) • Application de la/des directive(s) du Conseil • Anwendbare EU-Richtlinie(n) • Applicazione delle Direttive • Aplicación de la(s) directiva(s) del consejo	Electrical Safety AS/NZS 60335-1:2020 +A1:2021 AS/NZS 60335-2-90:2017 +A1:2020				
	Electro-Magnetic Compatibility				
	FB861-A	FB862-A	FB864-A	FB865-A	
	EN 55014-2:2015	■	■		
	EN IEC 55014-1:2021				■
	EN IEC 55014-2:2021	■	■		■
	EN 55011:2016+A2:2021			■	■
	EN 55011:2016 +A1:2017 +A11:2020	■	■	■	■
	EN IEC 61000-3-2:2019 +A1:2021	■	■	■	■
	EN 61000-3-3:2013 +A1:2019 +A2:2021	■	■		■
	EN IEC 61000-6-1:2019			■	
	EN IEC 61000-3-11:2019			■	■
	EN 55032:2015 +A11:2020 +A1:2020				■
	EN 55035:2017 +A11:2020				■
	IEC 61000-6-1:2016			■	
	IEC 61000-3-2:2018 +A1:2020			■	
	IEC 61000-3-11:2017			■	
Manufacturer Name • Naam fabrikant • Nom du fabricant • Name des Herstellers • Nome del fabbricante • Nombre del fabricante		Apuro			

I, the undersigned, hereby declare that the equipment specified above conforms to the above Territory Legislation, Directive(s) and Standard(s).

Ik, de ondergetekende, verklaar hierbij dat de hierboven gespecificeerde uitrusting goedgekeurd is volgens de bovenstaande Richtlijn(en) en Standaard(en).

Je soussigné, confirme la conformité de l'équipement cité dans la présente à la / aux Directive(s) et Norme(s) ci-dessus
Ich, der/die Unterzeichnende, erkläre hiermit, dass das oben angegebene Gerät der/den oben angeführten Richtlinie(n) und Norm(en) entspricht.

Il sottoscritto dichiara che l'apparecchiatura di sopra specificata è conforme alle Direttive e agli Standard sopra riportati.
El abajo firmante declara por la presente que el equipo arriba especificado está en conformidad con la(s) directiva(s) y estándar(es) arriba mencionadas.

Date • Data • Date • Datum • Data
• Fecha

26th Sep 2024

Signature • Handtekening • Signature
• Unterschrift Firma • Firma

DocuSigned by:

Ashtley Hooper
B39382C9FD9C478...

DocuSigned by:

Brendan
386FAD00DFE8483...

Full Name • Volledige naam • Nom et prénom • Vollständiger Name •
Nome completo • Nombre completo
Position • Functie • Fonction •
Position • Qualifica • Posición

Group Head of Product Quality & Compliance

Commercial Manager/ Responsible Supplier

Manufacturer Address • Adres fabrikant • Adresse du fabricant •
Adresse des Herstellers • Indirizzo del fabbricante • Dirección del fabricante

**Fourth Way,
Avonmouth,
Bristol,
BS11 8TB
United Kingdom**

**15 Badgally Road,
Campbelltown
NSW 2560**



apuro

FB862-A_A5_v3_2025/06/23